

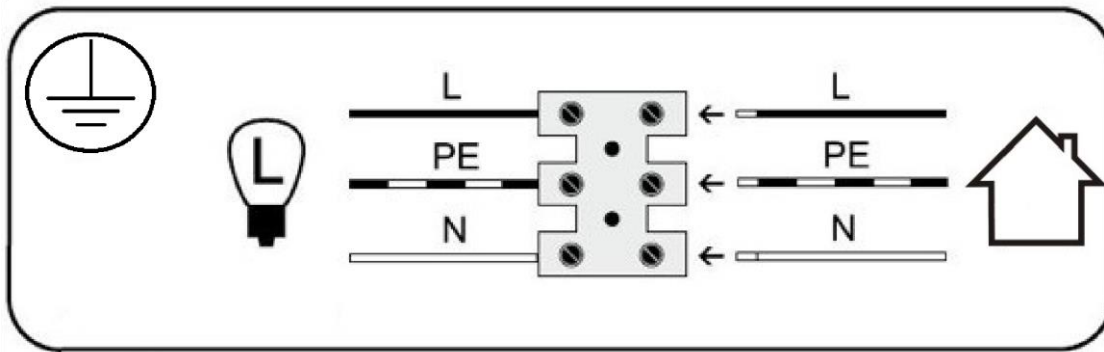







E14 LED MAX 7W 







**DE**

<b>L1</b> Stromleitung (Phase) braun	<b>L</b> Stromleitung (Phase) schwarz	<b>PE</b> Schutzleitung (gelb/grün)	<b>N</b> Neutraler Leiter (null)
 Schutzklasse II Lampe ohne Schutzleitung	 Schutzklasse I Lampe mit Schutzleitung	 Symbol für den Netzanschluss auf der Lampenseite	 Symbol für den Netzanschluss auf der Hausseite

**ENG**

<b>L1</b> Power wire (phase) brown	<b>L</b> Power wire (phase) black	<b>PE</b> Protective wire (yellow/green)	<b>N</b> Neutral wire (blue)
 Protection class II Lamp without protective conductor	 Protection class I Lamp with protective conductor. Protective conductor - symbol.	 Symbol for mains connection on the lamp side	 Symbol for connection to the mains from the side of the house

**PL**

<b>L1</b> Przewód prądowy (faza) brązowy	<b>L</b> Przewód prądowy (faza) czarny	<b>PE</b> Przewód ochronny (żółto/zielony)	<b>N</b> Przewód zerowy (neutralny) niebieski
 Klasa ochronna II Lampa bez przewodu ochronnego.	 Klasa ochronna I Lampa z przewodem ochronnym. Przewód ochronny - symbol	 Symbol Podłączenie do sieci od strony lampy	 Symbol Podłączenie do sieci od strony domu